

Operating Manual

--CN57 Industrial Coil Nailer--

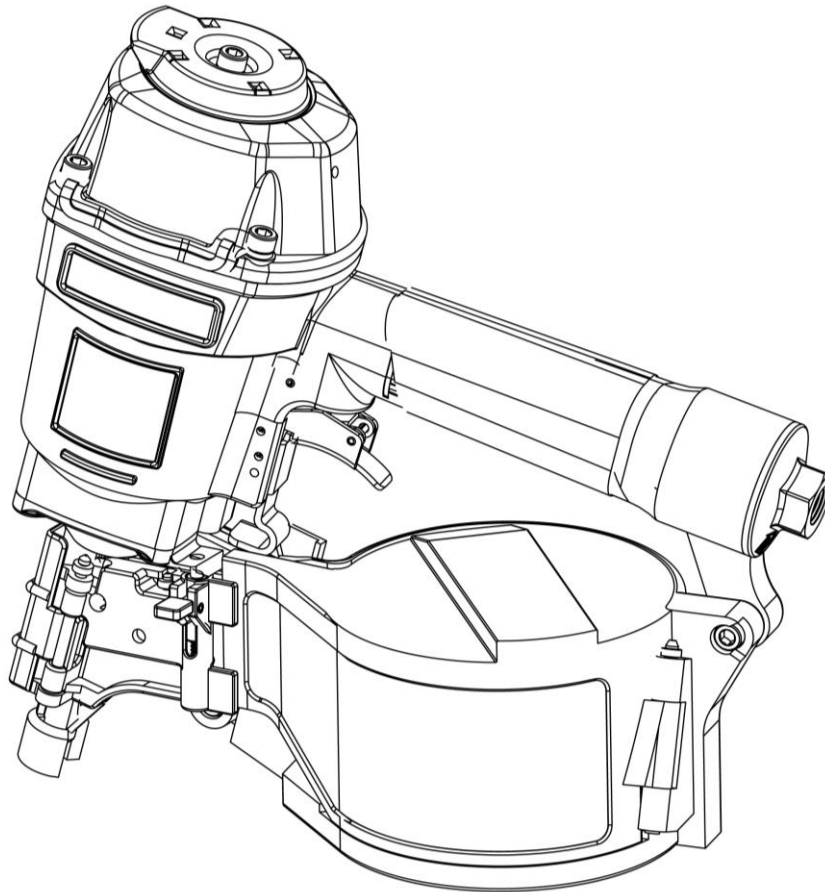

NOTE: Please read and fully understand the instructions in this manual before operating the pneumatic power tool. Carefully read through this OPERATOR'S MANUAL to ensure efficient, safe operation. It is recommended that the Manual be kept readily available as an important reference when using this tool.

CE

IMPORTANT INFORMATION



WARNING: The warnings, cautions and instructions discussed in this instruction manual cannot cover all possible conditions and situations that may occur. It must be understood by the operator that common sense and caution are factors which cannot be built into this product, but must be supplied by the operator.

When using the tool, basic safety precautions should always be followed to reduce the risk of personal injury and damage to equipment.

Read and understand tool labels and operating instructions, safety precautions and warnings in this manual before operating or maintaining this nailer.

Failure to follow warnings could result in **DEATH** or **SERIOUS INJURY**.

Most accidents that result from the operation and maintenance of nailers are caused by the failure to observe basic safety rules or precautions. An accident can often be avoided by recognizing a potentially hazardous situation before it occurs and by observing appropriate safety procedures.

Basic safety precautions are outlined in the "**SAFETY**" section of this manual and in the sections which contain the operation and maintenance instructions. Hazards that must be avoided to prevent bodily injury or tool damage are identified as **DANGERS** or **WARNINGS** on the nailer and in this manual.

Never allow the nailer to be operated by children or individuals who have not reviewed this manual.

OPERATE THE NAILER ACCORDING TO THIS MANUAL.



WARNING!

Always follow the tool manufacturer's safety and maintenance instructions.

Always wear safety glasses with side shields when operating or servicing tools.

Always disconnect the air supply from the tool and empty the magazine when servicing tools.

**SAVE THIS MANUAL
FOR FUTURE REFERENCE!**

WARNING:

The operating instructions shall draw attention to the following

a) Only those fasteners listed in the operating instructions may be used in the fastener driving tools;

NOTE: The fastener driving tool and the fasteners listed in the operating instructions must be seen as one unit system in terms of technical safety.

b) Only the main energy and the lubricants listed in the operating instructions may be used;

c) Fastener driving tools marked with an inverted equilateral triangle standing on one point may only be used with an effective safety yoke;

d) Fastener driving tools equipped with contact actuation or continuous contact actuation, marked with the symbol “Do not use on scaffoldings, ladders”, shall not be used for specific application for example:

when changing one driving location to another involves the use of scaffoldings, stairs, ladders, or ladder alike constructions, e.g. roof laths, closing boxes or crates, fitting transportation safety systems e.g. on vehicles and wagons;

e) For the maintenance of fastener driving tools, only spare parts specified by the manufacturer or his authorized representative shall be used;

f) Repairs shall be carried out only by agents authorized by the manufacturer or by other specialists, having due regard to the information given in the operating instructions;

NOTE: Specialists are those who, as a result of professional training or experience, have sufficient expertise in the field of fastener driving tools and sufficient familiarity with relevant governmental industrial protection provisions, accident prevention regulations, directives and generally recognized technical regulations (e.g. CEN- and CENELEC-standards), to be able to assess the safe working condition of fastener driving tools.

g) Stands for mounting the fastener driving tools to a support for example a work table, shall be designed and constructed by the stand manufacturer, in such a way that the fastener driving tool can be safely fixed for the intended use, thus for example avoiding damage, distortion or displacement.

Additional instructions for fastener driving tools operated by compressed air

a) Fastener driving tools operated by compressed air shall only be connected to compressed air lines where the maximum allowable pressure cannot be exceeded by a factor of more than 10%, which can for example be achieved by a pressure reduction valve which includes a downstream safety valve;

b) When using fastener driving tools operated by compressed air, particular attention must be paid to avoid exceeding the maximum allowable pressure;

c) Fastener driving tools operated by compressed air should only be operated at the lowest pressure required for the work process at hand, in order to prevent unnecessarily high noise levels, increased wear and resulting failures;

d) Hazards caused by fire and explosion when using oxygen or combustible gases for operating compressed air operated fastener driving tools.

SAFETY INFORMATION



WARNING:

BEFORE USING THE TOOL, READ CAREFULLY AND UNDERSTAND THE FOLLOWING SAFETY INSTRUCTIONS. FAILURE TO FOLLOW WARNING COULD RESULT IN DEATH OR SERIOUS INJURY.



1. WEAR SAFETY GLASSES OR GOGGLES.

Danger to the eyes always exists due to the possibility of dust being blown up by the exhausted air or of a fastener flying up due to the improper handling of the tool. For these reasons, safety glasses or goggles shall always be worn when operating the tool. The employer and/or user must ensure that proper eye protection is worn. The employer is responsible to enforce the use of eye protection equipment by the tool operator and all other personnel in the work area. NOTE: Non-side shielded spectacles and face shields alone do not provide adequate protection.



2. EAR PROTECTION MAY BE REQUIRED IN SOME ENVIRONMENTS.

As the working condition may include exposure to high noise levels which can lead to hearing damage, the employer and user should ensure that any necessary hearing protection is provided and used by the operator and others in the work area.



3. DO NOT USE ANY POWER SOURCE EXCEPT AN AIR COMPRESSOR.

The tool is designed to operate on compressed air. Do not operate the tool on any other high pressure gas, combustible gases (e.g. Oxygen, acetylene, etc.) since there is the danger of an explosion. For this reason, absolutely so not use anything other than an air compressor to operate the tool.

4. OPERATE WITHIN THE PROPER AIR PRESSURE RANGE.

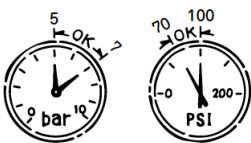

The tool is designed to operate within an air pressure range of 70 psi to 100 psi (5 to 7 bar). The pressure should be adjusted to the type of the work being fastened. The tool shall never be operated when the operating pressure exceeds 120 psi. (8.3 bar).



5. DO NOT OPERATE THE TOOL NEAR A FLAMMABLE SUBSTANCE.

Never operate the tool near a flammable substance (e.g., thinner, gasoline, etc.). Volatile fumes from these substances could be drawn into the compressor and compressed together with the air and this could result in an explosion.

6. DO NOT USE A WRONG FITTING.

The connector on the tool must not hold pressure when air supply is disconnected. If a wrong fitting is used, the tool can remain charged with air after disconnecting and thus will be able to drive a fastener even after the line of air is disconnected, possibly causing injury.

7. DISCONNECT THE AIR SUPPLY AND EMPTY THE MAGAZINE WHEN THE TOOL IS NOT IN USE.

Always disconnect the air supply from the tool and empty the magazine when operation has been completed or suspended, when unattended, moving to a different work area, adjusting, disassembling, or repairing the tool, and when clearing a jammed fastener.

8. INSPECT SCREW TIGHTNESS.

Loose or improperly installed screws or bolts cause accidents and tool damage when the tool is put into operation. Inspect to confirm that all screws and bolts are tight and properly installed prior to operating the tool.

9. DO NOT TOUCH THE TRIGGER UNLESS YOU INTEND TO DRIVE A FASTENER.

Whenever the air supply is connected to the tool, never touch the trigger unless you intend to drive a fastener into the work. It is dangerous to walk around carrying the tool with the trigger pulled, and this and similar actions should be avoided.

10. NEVER POINT THE DISCHARGE OUTLET TOWARD YOURSELF AND PERSONNEL.

If the discharge outlet is pointed toward people, serious accidents may be caused when misfiring. Be sure the discharge outlet is not pointed toward people when connecting and disconnecting the hose. Loading and not loading the fasteners or similar operations.

11. USE SPECIFIED FASTENERS.

The use of fasteners other than specified fasteners will cause the tool malfunction. Be sure to use only specified fasteners when operating the tool.

12. PLACE THE DISCHARGE OUTLET TO THE WORK PROPERLY.

Failure to place the discharge outlet of the nose in a proper manner can result in a fastener flying up and is extremely dangerous.

13. KEEP HANDS AND BODY AWAY FROM THE DISCHARGE OUTLET

When loading and using the tool, never place a hand or any part of body in fastener discharge area of the tool. It is very dangerous to hit the hands or body by mistake.

14. DO NOT DRIVE FASTENERS CLOSE TO THE EDGE AND CORNER OF THE WORK AND THIN MATERIAL

The work piece is likely to split and the fastener could fly and hit someone.

15. DO NOT DRIVE FASTENERS ON THE TOP OF OTHER FASTENERS.

Driving fasteners on the top of other fasteners may cause deflection fasteners which could cause injury.

16. REMOVING THE FASTENERS AFTER COMPLETING OPERATION

If fasteners are left in the magazine after the completion of operation, there is the danger of a serious accident occurring prior to the resumption of operation, should the tool be handled carelessly, or when connecting the air removes all fitting. For this reason, always move the fasteners away which remaining in the magazine after completion of the operation.

17. CHECK OPERATION OF THE CONTACT TRIP MECHANISM FREQUENTLY IN CASE OF USING A CONTACT TRIP TYPE TOOL

Do not use the tool if the trip is not working correctly as accidental driving of a fastener may result. Do not interfere with the proper operation of the contact trip mechanism.

18. WHEN USING THE TOOL OUTSIDE OR ELEVATED PLACE.

When fastening roofs or similar slanted surface, start fastening at the lower part and gradually work your way up. Fastening backward is dangerous as you may lose your foot place. Secure the hose at a point close to the area you are going to driver fasteners. Accidents may be caused due to the hose being pulled inadvertently or getting caught.

19. NEVER USE THE TOOL IF ANY PORTION OF THE TOOL CONTROLS (e.g., TRIGGER, CONTACT ARM) IS INOPERABLE DISCONNECTED, ALTERED OR NOT WORKING PROPERLY.

20. NEVER ACTUATE THE TOOL INTO FREE SPACE.

This will avoid any hazard caused by free flying fasteners and excessive strain of the tool.

21. ALWAYS ASSUME THAT THE TOOL CONTAINS FASTENERS.

22. DO NOT USE ON SCAFFOLDINGS LADDERS.



The tool shall not be used for specific application for example:

- When changing one driving location to another involves the use of scaffoldings, stairs, ladders, or
- Ladder alike constructions, e.g. roof laths,
- Closing boxes or crates,
- Fitting transportation safety systems e.g. on vehicles and wagons.

TECHNICAL DATA

Type of tool	CN57 Industrial Coil Nailer
Dimensions	270mmX131mmX283mm
Weight (without fasteners)	2.50kgs
Actuation mode	Contact actuation
Magazine capacity	300-350 nails
Maximum allowable pressure	8.3 bar (120psi)
Recommended pressure range	5 bar to 7 bar (70psi to 100psi)

Fasteners

Only the nail sizes shown in the table below can be driven with this nailer.

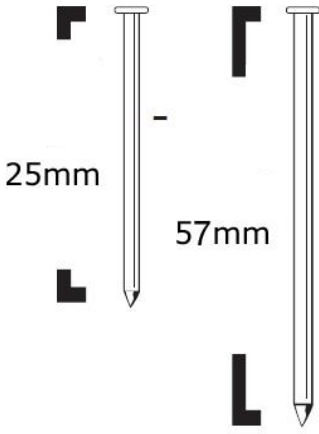
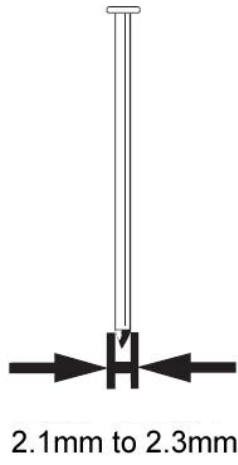
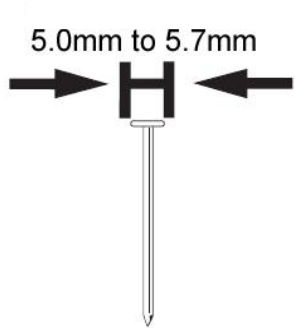
15° Wire welded coil nails		
Nail Length	Shank Diameter	Head Diameter
 <p>25mm</p> <p>57mm</p>	 <p>2.1mm to 2.3mm</p>	 <p>5.0mm to 5.7mm</p>

Applications

- Making pallets, drums and export wooden boxes;
- Crating;
- Making wooden fence;
- General construction applications.

NAILER CONNECTION AND OPERATION

NOTE: The information contained in this manual is designed to assist you in the safe operation of the nailer. Some illustrations in this Manual may show details or attachments that are different from those on your nailer.

Air Supply, Connections and Operating Pressure

Read section titled **SAFETY**. Make sure of the following before operation: **Air Supply Power Source (Compressor)**

- Use only clean, dry, regulated compressed air as a power source for this nailer.
- NEVER use oxygen or other bottled gases, as an explosion may occur.
- Use suitable air compressors used to supply compressed air to this nailer
- Moisture or oil in the air compressor may accelerate wear and corrosion in the nailer.
- Drain daily.

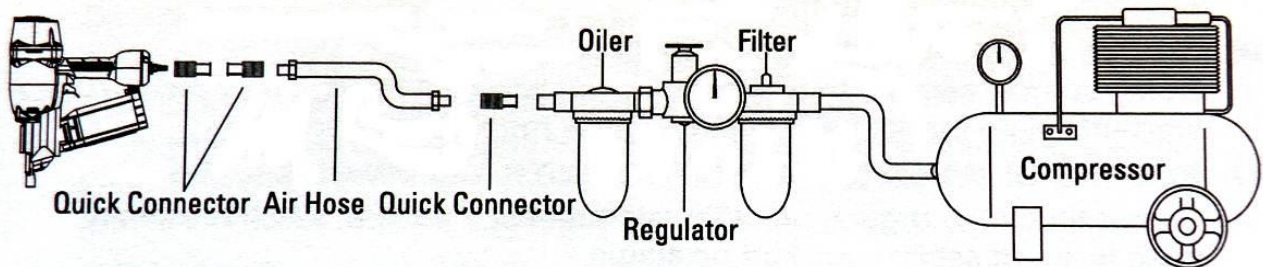

Connections

1. Fittings

Install a female coupler to the hose. The female coupler will connect to the quick release that fits the tool.

2. Filter-Regulator-Lubricator

- NEVER connect nailer to pressure which potentially exceeds 120psi.
- Filter-regulator-lubricator units supply an optimum condition for the nailer and extend the nailer life. These units should always be used.

Filter

- The filter removes moisture and dirt mixed in compressed air.
- Keep the filter clean by maintaining tool regularly.
- Drain daily.

Regulator

- The regulator controls the operating pressure for safe operation of the nailer.
- Inspect the regulator before operation to be sure it operates properly.

Nailer Connection and Operation

Lubricator

- The lubricator supplies and oil mist to the nailer.
- Inspect the lubricator before operation to be sure the supply of lubricant is adequate.
- If an inline lubricator is not used, a few drops of oil will need to be added to the nailer inlet before each use.

3. Air Hose

Air hose must have a minimum working pressure rating of 180 psi.

Hose has a min. ID of 1/4"(ISO 7-1) and max. length of no more than 17'(5 meter).

The supply hose should contain a fitting that will provide "quick disconnecting" from the male plug on the tool.

Operating Pressure

- Recommended operating pressure range is 70 to 100 psi.
- Maximum permissible operating pressure is 120 psi.
- Select the operating pressure within this range for the best fastener performance. The nail length and thickness and the hardness of the wood are factors in determining what the pressure should be set at.
- Do not exceed this recommended operating pressure.

NOTE: Dirt and water in the air supply are major causes of wear in the tool.

An air filter will help to get the best performance and minimum wear from the tool. Frequent, but not excessive, lubrication is required for the best performance. Oil added through the air line connection will lubricate the internal parts.

WARNING



NEVER connect nailer to pressure which potentially exceed 120psi.

DO NOT USE THE WRONG FITTING ON NAILER.

The nailer and air hose must have a hose coupler so that all pressure is removed from the nailer when the coupler is disconnected. The connector on the tool must not hold pressure when the air supply is disconnected. If the wrong fitting is used, the tool can remain charged with air after disconnecting and thus will be able to drive a nail even after the air line is disconnected, possibly causing injury.

DANGER



NEVER use oxygen or other bottled gases, as an explosion may occur.

INSTRUCTION FOR OPERATION

1. Before operation

- (1) Wear safety glasses or goggles
- (2) Do not connect the air supply
- (3) Inspect screw tightness
- (4) Check operation of the contact arm & trigger if moving smoothly
- (5) Connect the air supply
- (6) Check the air-leakage.(the tool must not have the air-leakage.)
- (7) Hold the tool with finger-off the trigger, then push the contact arm against the work-pieces.(the tool must not operate.)
- (8) Hold the tool with contact arm free from work-piece and pull the trigger.(the tool must not operate.)

2. Operation

Keep hands and body away from the discharge outlet when driving the fasteners because of dangerous of hitting the hands or body by mistake.

Nail loading

- (1) Disconnect the air hose.
- (2) Press LATCH (210690) to open DOOR (210360), then open MAGAZINE COVER (420800).
- (3) Adjust the height of NAIL SUPPORT (321360) according to nails length.
- (4) Fix the first nail in the groove on FEED PAWL (210380).
- (5) Close MAGAZINE COVER (420800), close DOOR (210360).
- (6) Connect the air hose.

Test operation

- (1) Adjust the air pressure at 70psi. (5 bar) and connect the air supply.
- (2) Without touching the trigger, depress the contact arm against the work-piece. Pull the trigger.(the tool must fire the fastener.)
- (3) With the tool off the work-piece, pull the trigger. Then depress the contact arm against the work-piece.(the tool must fire the fastener.)
- (4) Adjust the air pressure as much as the lowest possible according to the diameters and length of fastener and the hardness of work-piece.

MAINTENANCE AND INSPECTION

Read the section title SAFETY.

SERVICE AND REPAIRS

All quality tools will eventually require servicing or replacement of parts due to wear from normal use. It is recommended that these operations should be performed by a professional technician.

NOTE: The information contained in this Manual is designed to assist you in the safe maintenance of the nailer. Some illustrations in this Manual may show details or attachments that are different from those on your nailer.

WARNING: Disconnect air hose and remove nails from nailer when:

- Doing maintenance and inspection
- Cleaning a jam

Inspecting the magazine

1. DISCONNECT AIR HOSE.
2. Clean the magazine. Remove dust which may have accumulated in the magazine.
3. Lubricate the nailer rail with nailer lubricant.

Clearing a jam

Remove a jammed nail in the following order:

1. DISCONNECT AIR HOSE.
2. Remove all nails.
3. Remove the jammed nail with a slotted head screwdriver.
4. In case of frequent jams, contact an authorized service center.

A qualified person should perform repair and maintenance

Periodic maintenance to be performed:

- Check that the piston bumper is operating normally. A damaged piston bumper may cause damages to other component parts.
- Check o-rings for wear or damage. Damaged o-rings may affect overall performance.
- Make sure all screws are secure. Loose screws may affect overall performance.
- When repairing a tool, make sure the internal parts are clean and lubricated.

Storing

- When not in use of an extended period, apply a thin coat of the lubricant to the steel parts to avoid rust.
- The nailer should be stored in a warm and dry place when not in use. Do not store the nailer in a cold weather environment.

PARTS LIST-CN57

NO.	CODE	Description	NO.	CODE	Description
1	610560	BOLT M6X20(Loctite)	49	110300	BODY
2	630070	SPRING WASHER 6	50	410460	HANDLE GRIP
3	320750	EXHAUST COVER	51	630110	SNAP RING 32
4	610220	BOLT M6X25	52	420540	FILTER
5	110290	CYLINDER CAP	53	620640	SAFETY SPRING
6	520310	GASKET	54	110310	END CAP
7	320460	RING	55	640340	ROLL PIN 3X16
8	410230	PISTON STOP	56	320560	CONTACT PLATE
9	620010	COMPRESSION SPRING	57	320570	TRIGGER
10	510700	O-RING 53X2.65	58	640180	ROLL PIN 3X30
11	510570	O-RING 41.2X3.55	59	322730	SAFETY BRACKET
12	310170	HEAD VALVE PISTON	60	510180	O-RING 5.8X1.9
13	510510	O-RING 37.5X3.55	61	330010	TRIGGER VALVE BUSHING
14	310280	PISTON	62	510210	O-RING 6.3X1.8
15	322240	DRIVER BLADE	63	510240	O-RING 8.6X1.9
16	410220	CYLINDER SEALING RING	64	620050	TRIGGER VALVE SPRING
17	310290	CYLINDER	65	320110	TRIGGER STEM
18	510680	O-RING 50X2.65	66	510030	O-RING 2.5X1.4
19	520130	CYLINDER SEAL	67	510410	O-RING 18.3X2.65
20	420780	CYLINDER RING	68	640250	STRAIGHT PIN A3X15
21	510850	O-RING 73X3.55	69	510380	O-RING 16X1.8
22	410210	BUMPER	70	420090	TRIGGER VALVE CAGE
23	322740	SAFETY	71	420800	MAGAZINE COVER
24	210670	NOSE	72	420240	SPRING HOLDER
25	420180	GUARD COVER	73	620650	MAGAZINE SPRING
26	511250	O-RING 49.5X2	74	321360	NAIL SUPPORT PLATE
27	510090	O-RING 4X1.5	75	420820	MAGAZINE
28	321300	DOOR PIN	76	610220	BOLT M6X25
29	420170	PIN CAP (A)	77	420160	PIN CAP (B)
30	210690	LATCH	78	321370	MAGAZINE PIN
31	621050	LATCH SPRING	79	420830	MAGAZINE POST
32	640080	ROLL PIN 3X12	80	630290	SNAP RING
33	210360	DOOR	81	610330	NUT M6
34	321310	CHECK PAWL PIN	82	610570	BOLT M6X32
35	210370	CHECK PAWL	84	420080	TRIGGER VALVE CAP
36	620600	CHECK PAWL SPRING	85	321380	SIDE PROTECTOR
37	210380	FEED PAWL	86	610210	BOLT M6X22 (Loctite)
38	620610	FEED SPRING	87	410880	STRAIGHT PIN CAP
39	320210	FEED PAWL PIN	88	323140	STRAIGHT PIN
40	321320	FEED PISTON	89	630030	FLAT WASHER
41	510300	O-RING 9.7X2.4	90	640340	ROLL PIN 3X16
42	510440	O-RING 20.8X2.4	91	321540	SPRING SEAT
43	620620	FEED PISTON SPRING (B)	92	510280	O-RING 9X2
44	321330	SPRING GUIDE	93	323180	WASHER
45	620630	FEED PISTON SPRING (A)	94	324520	TRIGGER SLEEVE
46	410420	FEED PISTON BUMPER			
47	321340	FEED PISTON CAP	P1	D322241	DRIVER UNIT
48	630050	SNAP RING 26	P2	T420091	TRIGGER VALVE

TOOL SCHEMATIC-CN57

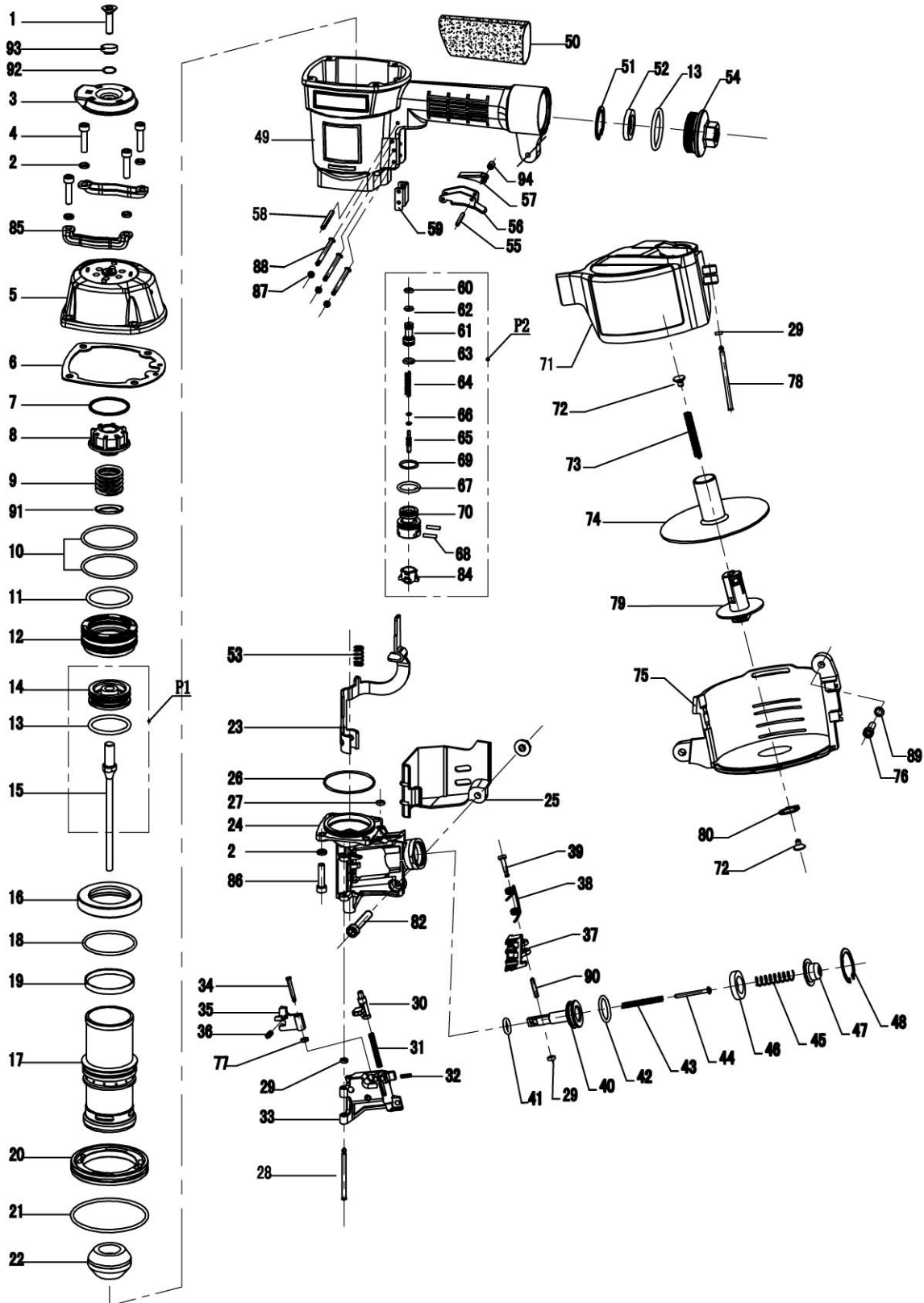

IMPORTER:

NOBE ApS
Bjødstrupvej 10
DK – 8410 Rønne
Denmark

Tel: + 45 8615 1913
E-Mail: info@nobe.dk

www.nobe.dk / www.rgneurope.com

--Industrial Coil Nailer CN57--
2016